

*(Version: 2024)*

**Leather:**  
**AN OVERVIEW OF MANUFACTURE**  
(Part 1)  
**The removal of unwanted materials**  
**and extension of the structure**

**Author: Richard P. Daniels**

**Recommended by:**



INTERNATIONAL UNION OF LEATHER  
TECHNOLOGISTS AND CHEMISTS SOCIETIES



UNITED NATIONS  
INDUSTRIAL DEVELOPMENT ORGANIZATION

## Leather: AN OVERVIEW OF MANUFACTURE

### **Content and Structure:**

**This section includes a summary of hides and skins as raw materials.**

**Part 1: The removal of unwanted materials and extension of the structure.**

**Part 2: The introduction of new materials and extension of the structure.**

**Part 3: The removal of water and reconfiguration to a flat form.**

**Part 4: Application of the finish.**

**Part 5: Different types of bovine leathers.**

**Part 6: Small skins: hair sheep and goat: grain leathers.**

**Part 7: Small skins: wool bearing sheep: double face, shearling and rugs.**

**Part 8: Discussion.**

### **Annex.**

*All rights reserved. This publication is for dissemination and study free of any associated charges. It should only be transmitted or used in its entire form. The rights of Richard Daniels to be identified as author of this work are asserted in accordance with the Copyright, Design and Patents Act 1988.*

**There are many different types of leathers produced from both hides and skins. As a starting point it is useful to follow the conversion of raw bovine hides into footwear leather using chromium compounds for tanning.**

**This is because:**

- Bovine hides are the main source of leathers produced.**
- The majority of leathers are used in footwear construction.**
- The use of chromium-based products has been established as the major tanning process for more than 100 years.**
- The manufacture of other leather types can relate to this technology, and are detailed as appropriate.**

**Procedures required for these footwear leathers are given as *Schematic 1a and 1b*:**

# Schematic 1: The conversion of hides into leather

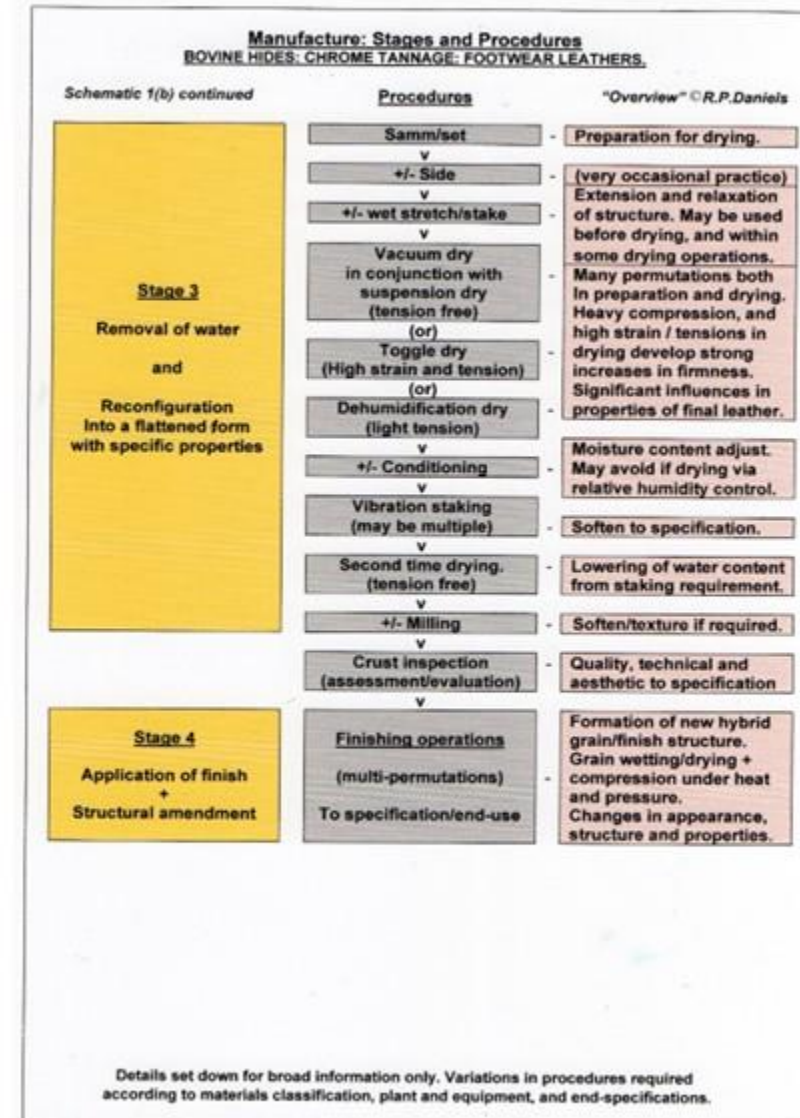
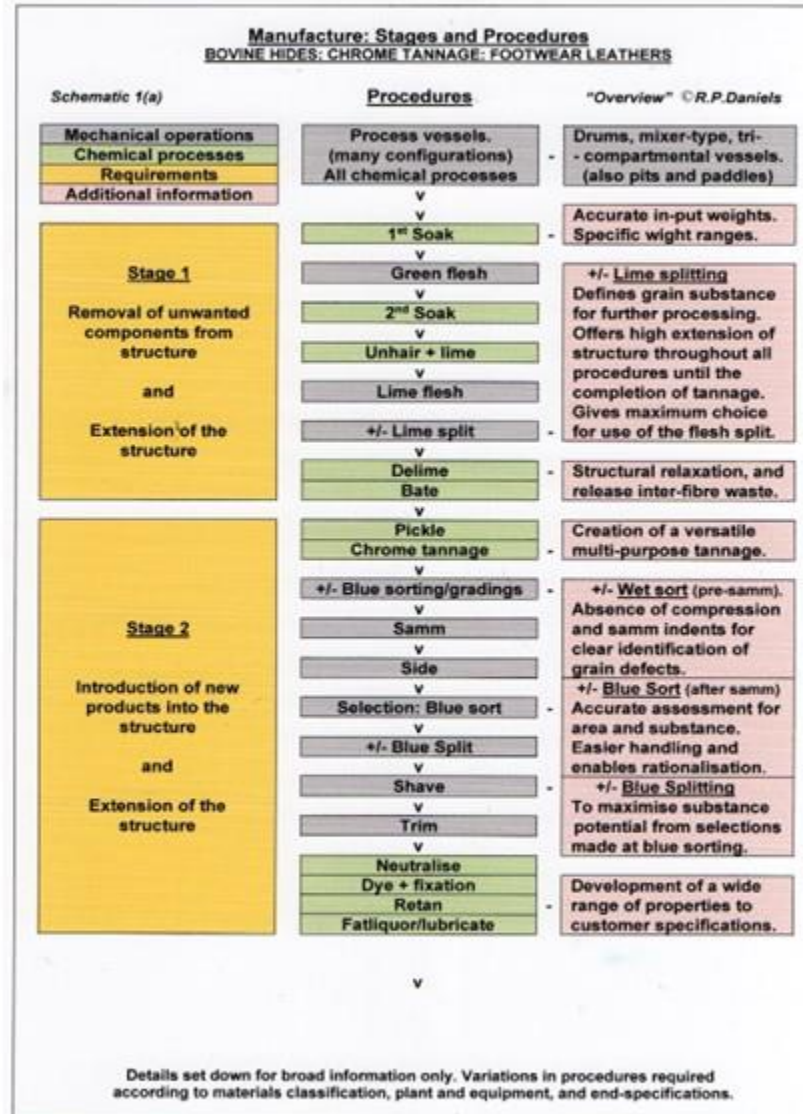

**These schematic identify four Stages within leather manufacture, and these are discussed in this and the following three Parts of Overview.**

**But first, it is useful to consider the processing vessels. These are central for the management of both the chemical processes and the significant forces applied to goods in process.**

**Drums are the most common type of vessel used for all operations.**

## The processing vessel and its operation

The basic processing drum.



Plant with full support systems.



- Traditionally, wooden drums are used for chemical processing.
- The role of these vessels is critical.
- On rotation, hides and chemicals in solution (*floats*) are mixed as part of the chemical process.
- Considerable forces are applied to the materials during these movements.
- These forces help determine the outcome from reactions as chemicals penetrate the hide structure.
- At the same time the structure is extended as part of shape change (*reconfiguration*) from a rounded to a flattened form.

**Shelves fitted in stainless steel drum.  
(Drain via perforated body section)**



**Pegs fitted in a wooden drum.  
(Drain via perforated side channels)**



- The forces applied are governed by the speed of rotation, the weight of the load, the volume of float, time, and internal construction.
- The most basic drum construction comprises 6 shelves set horizontally across the drum body.
- These apply a moderate drop action, but also cause a rolling motion to the goods that can cause tangling.
- Pegs provide a more gentle and continuous teasing action and help avoid tangling.
- Combinations of the two are common.

**Deep shelf fittings: 4 shelves in this vessel.**



**One section of a stainless steel Y section vessel with elongated pegs.**



- **Shelves at between 25 - 40% of the drum radius are also fitted.**
- **These apply a high lift and drop action.**
- **They provide good mechanical action and help avoid tangling.**
- **Known as deep shelf drums, they are fitted at 3 or 4 shelves per drum according to shelf length.**
- **Tri-compartmental (or Y section vessels) are also used for more delicate leathers.**
- **The drum is divided into 3 sections by perforated divisions.**
- **These normally have small pegs fitted to help avoid tangling.**



**Stainless steel hide processors.**



**Paddles: wood and polypropylene.**



- **Polypropylene and stainless steel are also used in constructions.**
- **And different types of vessels are employed, including specialised processors.**
- **Various internal arrangements of shelves and pegs are used in all vessels for the movement of goods and floats in process and the application of force.**
- **Paddle arrangements are used occasionally.**

## Stage 1 procedures

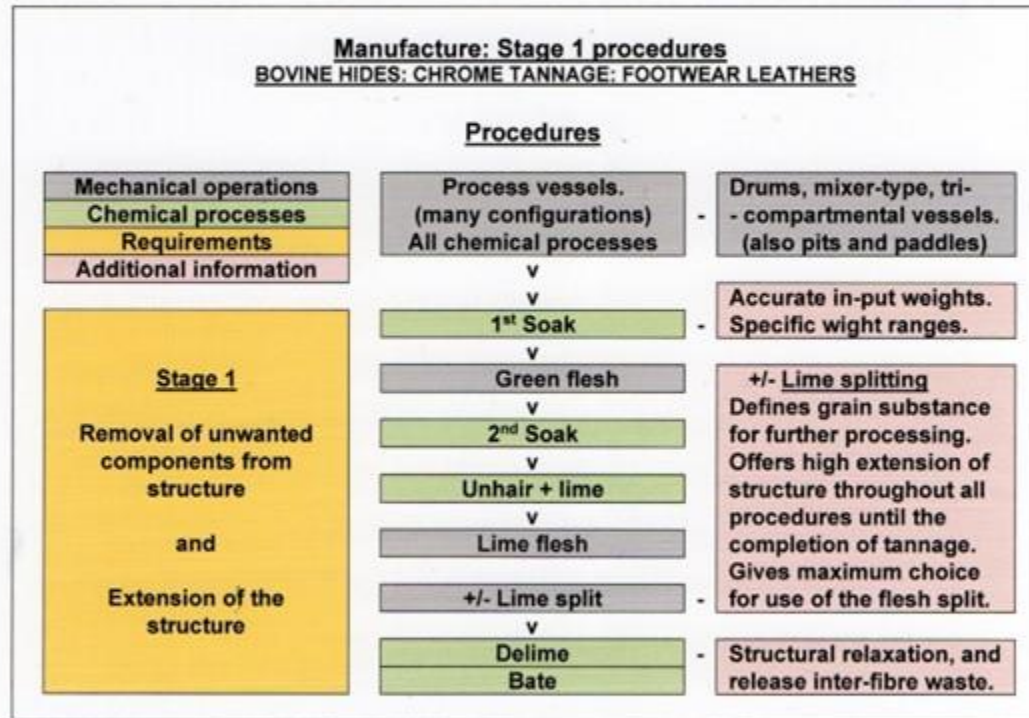

- Within Stage 1 procedures a strong and flexible collagen matrix is provided for the final leather.
- The procedures used are part of a gradual extension of the hides and skins from a natural rounded structure to a flattened form.
- This involves both chemical modification of the hides and skins, and the careful application of force throughout all processes and operations.

## SOAKING PROCEDURES

**The objective of soaking is to remove salt, dirt and contaminants from the skin and fully rehydrate the skin/protein structure. This is in preparation for the unhairing and liming process.**

**Soaking times can vary from a few hours for fresh hides to several days for some types of air-dried hides.**

**Bactericides are included to prevent decay of the skin, and wetting agents / detergents, mild alkalis, and selected enzymes can be used to accelerate the soak.**

## Preparation for soaking

Loading a desalting cage.



Desalting cage and enclosed conveyor for drum feed.



- The hides may be fresh or salted.
- Salted hides are often loaded into open cages and tumbled to remove loose surface salt and to open the hides.
- On exit from the cage they can be transported to specified drums using conveyor belts and delivery chute arrangements.

**Hide movement by forklift truck.**



**Grab manipulator for drum loading.**



- **Various techniques are used for loading into the soaking vessels.**
- **Forklift trucks are used extensively, as well as grab manipulators too.**

**Hide delivery by line-conveyor.**



**Load cell for weighing each hide.**



- **Hides are weighed as they enter production to ensure accuracy in chemical use in subsequent processing.**
- **This may be before loading by forklift or grab, or on a line-conveyor using sensors set on the delivery lines.**
- **When using conveyors, hides can be directed automatically to drums according to the weight range and to a specified load weight.**

## 1<sup>st</sup> soaking process

Hide discharge after dirt soak.



Hides for delivery to fleshing.



- The 1st soak removes some dirt and salt from the structure.
- It is not intended to fully rehydrate the hide.
- Flesh may be cut from the hides at this stage, with trucks or line conveyors used for transport to the operation.
- Known as “green fleshing” some hide flexibility is needed for good extension in this operation, but with sufficient firmness for good cutting.
- If there is little residual flesh this operation is often omitted and the soaking processing continues without unloading.

*(Fleshing operations: Pages 25-31)*

## The 2<sup>nd</sup> soaking process

Hides reloaded if green fleshed.



Inspection of fully wetted hide.



- If the hides are green fleshed, they are reloaded for the 2<sup>nd</sup> soak (*main soak*).
- This fully cleans and rehydrates the structure in preparation for the unhairing and liming processes.
- The hides are inspected after the main soak to ensure that they are thoroughly wet back, especially the thick and densely structured parts.
- This is to ensure uniformity in the unhairing and liming processes.
- These processes can take place in the vessel used for soaking, but hides are often unloaded and transferred to another area.



## Review:

**There are two soaking stages:**

### ***1<sup>st</sup> Soak:***

**The objective is to remove dirt, salt and contaminants from the surface. This is not a complete soaking of the skin and leaves a firm structure.**

**There may be a fleshing operation after the 1<sup>st</sup> soak, but depending upon the amount of residual flesh this machine operation is often avoided.**

### ***2<sup>nd</sup> Soak:***

**Hides are fully hydrated in preparation for unhairing and liming, with some non-structured proteins dissolved and released from within the structure.**

**Once the hides are fully soaked the unhairing phase can commence.**

## UNHAIRING AND LIMING PROCEDURES

There are two types of unhairing and liming processes:

### *Hair dissolving processes:*

Under alkaline conditions, the chemicals sodium sulfide and sodium hydrosulfide can break down the protein keratin - the main component of hair – leaving the collagen structure intact. It is therefore possible, under careful control, to safely remove hair from the skin without causing damage to the sensitive grain layer.

This hair removal is carried out as the first step of a combined unhairing/liming process where the hair breaks down into solution.

This often referred to as a hair-burn process.

***Hair saving processes:***

**Hair can be removed from the hide largely intact instead of dissolving it.**

**The technique is similar to the hair dissolving system, but the hair shaft is first made chemically immune to breakdown by a small pre-addition of lime.**

**The hair root is then dissolved using mainly sodium hydrosulfide, the released hair being separated intact from the float using specialised filtration equipment.**

**Regardless of technique, after hair removal the hides enter the liming stage. Here, they are subjected to controlled alkali swelling to cause an opening or separation throughout the fibre structure. Mainly uses calcium hydroxide (*lime*) as the source of alkali, often with additional sodium sulfide. Controlled additions of water are used for management of the swelling.**

## Unhairing and liming

Fully soaked hides pre-unhairing.



Hides slightly swollen with hair loosened after 2 hrs processing.



*The removal of hair:*

- Water additions (*the float*) are carefully controlled for volume and temperature.
- The volume affects the chemical concentrations, and temperature the breakdown rate of hair and modifications of the collagen structure.
- Additions of mainly sodium hydrosulfide/sulfide are required to start breakdown of the hair.
- At the end of the hair loosening stage the hides are slightly alkaline-swollen.

**Hair easily removed from the grain.**



**Hair filtered from the processing float.**



- **At this point in the process, the residual hair can be readily pushed from the hide.**
- **This leaves a clean grain surface.**
- **The process can continue with the hair being fully dissolved, or removed from solution and dewatered.**
- **In either event, the hides are in a suitable state for the liming stage.**

**Swollen hides at the end of liming.**



**Removal of hides from the area.**



### ***The liming stage:***

- **Addition(s) of lime +/- sodium sulfide and an increase in the float level by water addition is needed in the liming stage.**
- **This causes a gradual swelling throughout the hide structure.**
- **Unwanted proteins are dissolved in this alkaline process, and the collagen fibres in the structure separated.**
- **This ensures that the final leather can achieve the softness and flexibility required.**
- **On discharge from the liming vessel the hides can be removed from the area by line-conveyor or forklift.**

## Review:

**Unhairing and liming is a two stage process where hair is first removed from the skin structure - either being dissolved or removed intact - followed by controlled alkali swelling.**

**The liming stage has a decisive effect on the character of the leather produced.**

**Lime is the main source of alkali in this process as it is only sparingly soluble in water and ensures a constant level of alkalinity.**

**Sodium sulfide can also be incorporated. When dissolved it may be viewed as providing both sodium hydrosulfide as the major unhairing aid, and sodium hydroxide or caustic soda. This makes the liming solution more alkaline and accelerates the process.**

**Other products - wetting agents, enzymes, sodium hydroxide, amines, urea and auxiliaries - can also be included in both the unhairing and liming steps.**

**Liming is carried out with three major objectives:**

- 1. Alkali swelling of the skin to physically separate and open the collagen fibre structure.**
- 2. To cause break down and solubilise non-structured proteins and complex sugars within the collagen structure that would harden the final leather unless removed before tanning.**
- 3. To chemically modify the collagen for the reception of chemicals used in tanning.**

**There is also partial hydrolysis of natural greases within the structure, and this assists in their removal. Flesh residues become swollen, too, and this helps in their removal during the limed fleshing operation.**

**These processes are generally performed in drums and sometimes in hide processors. It is usually managed with handling over a 24 hour-cycle but this varies depending on the type of skin, and the type of leather to be produced.**



## FLESHING OPERATIONS

There are two different types of fleshing:

### *Green fleshing:*

Removes flesh from the hide structure if relatively large quantities remain. This is performed after 1<sup>st</sup> soak (*or dirt soak*) and before the 2<sup>nd</sup> soak (*main soaking stage*). This step is often omitted.

### *Limed fleshing:*

Performed after liming and unhairing as an essential step in preparation for the lime splitting operation.

Two types of machines are available for these operations.

## The basic fleshing machine (*out-feed action*)

Transport rollers and fleshing cylinder arrangements.

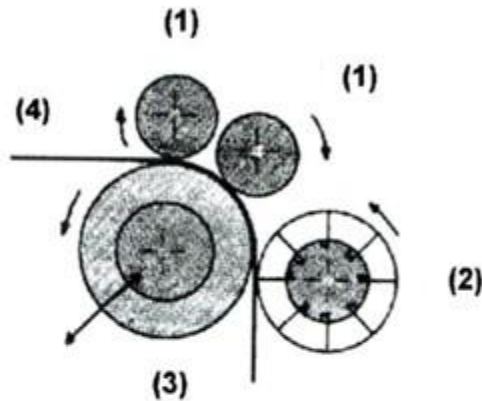

Knife cylinder and transport rollers.



- 1) Transport (*grip or feed*) rollers.
- 2) Knife cylinder: steel roller fitted with spiral knife blades (*helical arrangement*).
- 3) Support roller: steel covered in rubber to accommodate differences in cross-hide thickness.
- 4) Hide: grain down – fleshing action on return feed.

The angle of the cutting blades ensures that the hide is well extended at the time of cutting/return feed.

This extension is part of the reconfiguration from a rounded shape towards a flat form.

**Placing hide on the support roller.**

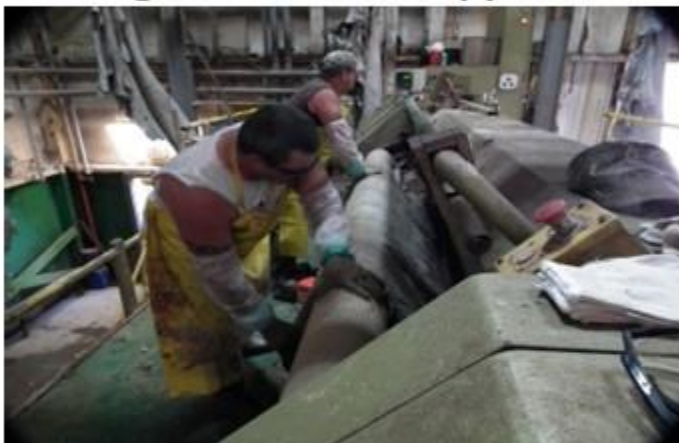

**Flesh cleanly removed on return feed.**



- **Limed hides are alkali swollen and rubbery in texture, but the roller assembly is designed to suit these properties.**
- **This swelling enables clean flesh removal from the structure.**
- **This removal ensures uniform chemical penetration in subsequent processing.**
- **The pressure applied to the hide during this operation squeezes dirt and hair debris from the grain.**
- **It also consolidates the structure in preparation for the limed splitting operation.**

## The fleshing machine (*through-feed action*)

Fleshing in through-feed is an alternative machine configuration:

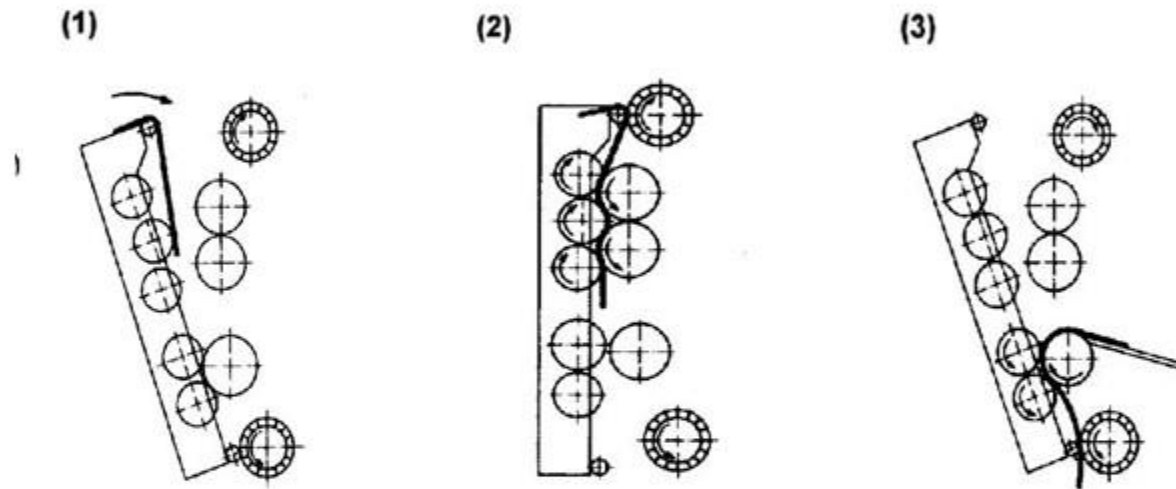

**Presentation and out-feed:**

- 1) Feed grain down as fleshing cycle commences.
- 2) Fleshing butt part.
- 3) Fleshing neck part on transport out of machine.

**Presentation: through feed operation.**



**Conveyor out feed from green fleshing.**



- **Handling of the hide is simplified in the through feed configuration.**
- **The hide is presented to the machine flesh side up.**
- **The through feed rate is very fast.**
- **Out feed is flat and grain side up.**
- **This suits conveyor belt linkage directly to the limed splitting operation.**
- **In this example the machine is being used for green fleshing.**

## Review:

### ***Green fleshing:***

**Can be used to cut surplus flesh from the hide after a dirt soak. This is to achieve a more uniform main soak and penetration of chemicals in the unhairing/liming processes. If the hides are relatively flesh-free, this operation is often omitted.**

### ***Limed fleshing:***

**Residual flesh and tissue is removed from the hide structure to ensure a clean skin for good presentation to the splitting operation. The operation squeezes dirt and debris from within the grain layer, and consolidates the structure.**

**The limed hides are slippery, firm, alkaline swollen, and semi-translucent. Any residual flesh and tissue can be cleanly cut from the flesh section. This is a very important operation, and it is unusual to rely on green fleshing alone.**

**Both types of fleshing are part of a general relaxation of the hide structure. They are particularly important for the removal of grease where the hide has a high natural fat content.**

**Handling procedures can be highly rationalised in this otherwise difficult operation.**

## LIMED SPLITTING OPERATION

Hides have considerable variations in thickness (*substance*) both across the hide structure and between individual hides.

By feeding the limed hide against a moving band knife, the swollen structure can be split horizontally into two layers, the top grain layer being uniform and to the required substance.

## Preparation for limed splitting

Protection: face shield for knife use, safety glasses for any splashes.



Hide delivery to splitting operation.



- After limed fleshing, the hides are well extended and clean.
- The hides can be stacked after fleshing, or moved from the area using a conveyor system.
- Trimming is required, with removal of any damaged peripheral parts for optimum presentation to the splitting operation.
- This operation is often performed on a horizontal belt conveyor placed behind the fleshing machine.
- This conveyor also enables direct presentation of the hides to the limed splitting operatives.



## The lime splitting operation (*through feed action*)

The splitting action.

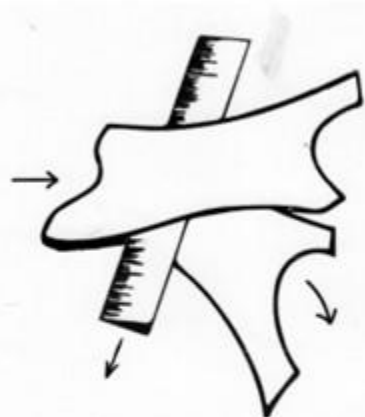

Presentation: limed splitting operation.



- The hide is delivered flat grain up on a belt conveyor to the operatives, or via a carefully positioned pallet of limed hides.
- The hide slides from the pallet / conveyor onto a stainless steel horizontal work or feed table.
- Using the feed table, the hide is presented to transport/grip rollers.
- These firmly hold the hide and feed it against a moving band knife blade.
- The hide is split into two horizontal layers.
- On completion, hide removal is part of the through feed action.

**Detail: two steel transport rollers and splitting blade arrangement.**

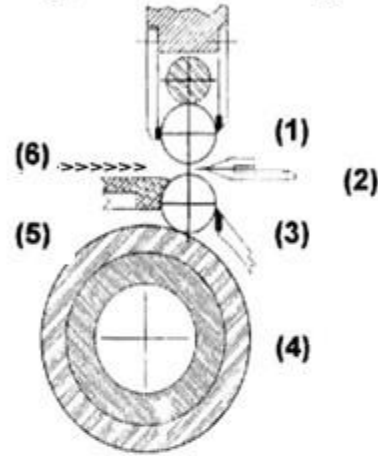

**Presentation: from feed table to transport rollers/band knife.**



- 1) **Steel transport roller.**
- 2) **The band knife.**
- 3) **Ring transport roller: Steel segments each approx. 3cm width free to rotate on a central flexible axle.**
- 4) **Support roller: steel covered in rubber.**
- 5) **Work or feed table.**
- 6) **Hide: grain up.**

**The support roller allows the steel segments to rise and fall and absorb variations in substance as the hide is fed through the cutting assembly.**

**The roller assembly evenly compresses the hide for horizontal splitting into two layers.**

**The upper layer (*grain layer*) is relatively uniform in substance – the flesh split carries irregularities.**

**Out feed: onto load cell, then conveyor delivery to drum.**



**Out feed: trimmed/graded flesh splits.**



- **After splitting, the grain split can be weighed for subsequent chemical processing, then delivered to the designated processing vessel.**
- **The flesh split, with the irregularities in thickness, may be inspected and trimmed on an out-feed conveyor before removal from the area.**
- **Limed fleshing, trimming, splitting and transfer of grain and flesh splits is managed mainly as a single production line.**
- **However, it can operate as batch production in smaller units.**

## Review:

**The variations in substance between the butt, shoulders, neck and belly areas of hides can be rectified by the lime splitting operation. By use of a band knife assembly the splitting machine can split a hide into two horizontal layers.**

**The most important section is the grain layer to provide accurate substance. The lower layer, termed the flesh split, carries any variation in substance. This can be processed separately to produce lower quality industrial gloving leather, shoe linings, suede leathers and laminates or for other purposes.**

**Splitting also enables a relaxation of the grain split, leading to a flattening effect and area increase. In addition, the reduced substance enables the chemicals used in subsequent processes to penetrate the hide more rapidly. This can shorten the time required for processing, and minimise both chemical offers and waste.**

## DELIMING AND BATING PROCESSES

**These processes are the final step for the removal of solubilised components from within the structure.**

**This avoids adhesions and fibre bondings in subsequent processing.**

## Deliming and bating

Lime split hides awaiting delime.



Inspection of delimed/bated hides.



- In the deliming process the split hides are neutralised from alkali to near-neutral conditions.
- This causes the hides to deswell.
- This releases solubilised proteins and fats from within the structure.
- Special enzymes - known as bating agents - are also applied.
- These processes produce a fibre matrix that is free from materials that would otherwise cause fibre adhesions.
- This provides a soft, clean and relaxed collagen structure for subsequent processing.

## Review:

### *The Deliming process:*

This is a step in a gradual change from the high pH liming condition towards the low pH acid state that is normal for most tanning methods. Ammonium salts can be used in this process although these are progressively being replaced by carbon dioxide gas and/or auxiliary products to reduce the nitrogen levels in subsequent wastewater treatment.

### *The Bating process:*

Specialised enzymes that best perform at slightly alkali to near neutral pH levels found in deliming are used to modify the protein structure. Deliming and bating processes can be applied in different floats or combined together.

### ***Degreasing actions:***

**When greasy hides are being processed, green and limed fleshing, and detergents and enzymes used during soaking, liming, deliming and bating all assist in grease removal.**

### ***Enzymes applications:***

**These can target, digest or modify very specific organic components with minimum environmental impact. Their use has been established in leather manufacture to assist the soaking, unhairing/liming, and bating processes via the digestion of non-structural proteins. They also help to rupture fat cell membranes to assist in the release of fat.**

**These applications are very specific. Enzymes must be used with great care otherwise the sensitive grain layer or the main corium structure can be damaged.**



## Opening the fibre structure and removal of unwanted components:

Fibre bundles with adhesions.

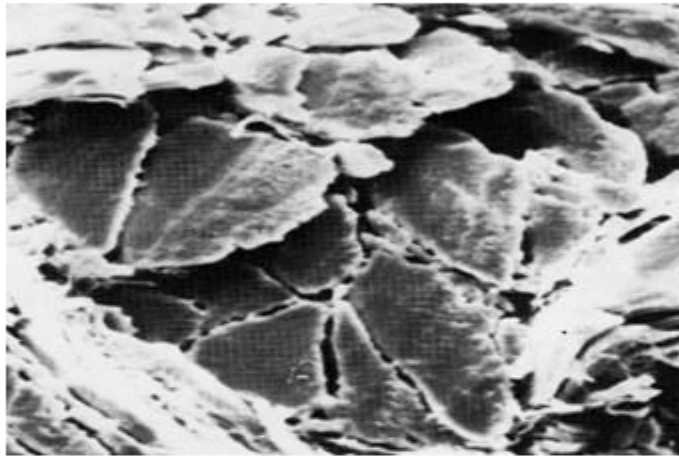

Well separated fibre bundles.



- If these first stages of processing are not managed correctly, the fibre bundles will not separate and adhesions will occur.
- The final leather will be hard and have a poor break.
- If the fibre bundles are well separated, a soft and flexible leather with good characteristics can be produced.

*(Images: Credit Betty Haines, BLMRA)*

**Leather folded grain inwards.**

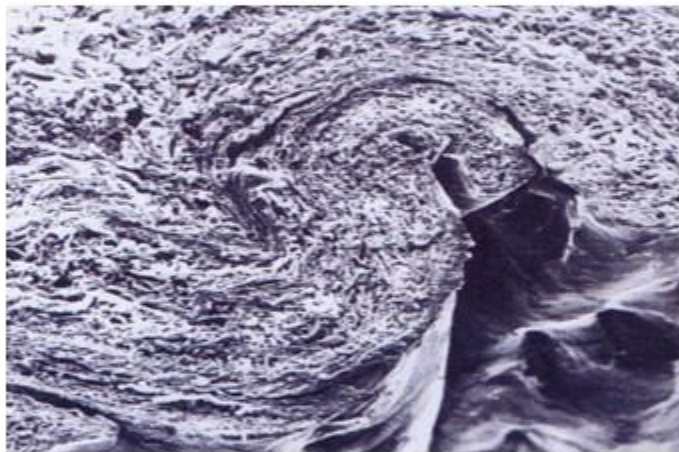

- **This fibre separation is essential for the appearance and performance of the final leather.**
- **It allows free movement within the final leather structure for comfort strength, and appearance.**
- **It enables good compression of the grain surface and extension of the supporting structure on folding and flexing.**

*(Images: Credit Betty Haines, BLMRA)*

**Well separated fibre structure.**

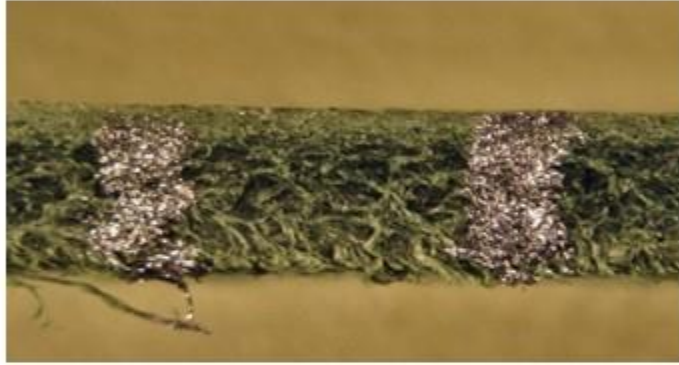

**Compression of grain and extension of main structure on folding.**

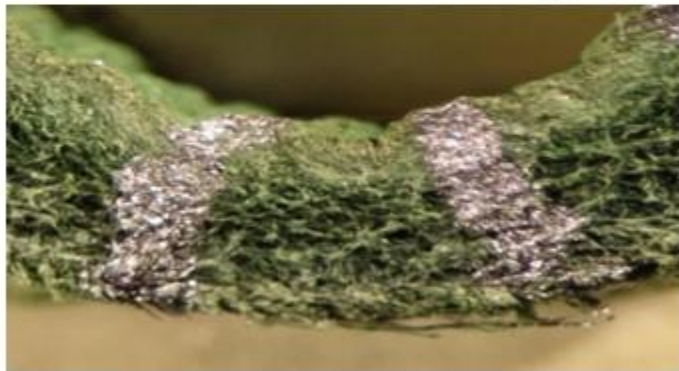

**This is also illustrated in the two images where the section markings show that:**

- **The grain layer can compress on folding, and the supporting fibre structure can expand.**
- **There is no distortion of the grain or development of coarse folds.**
- **Structural stress is minimised for long user life as a final product.**
- **This free movement throughout the fibre structure is made possible in the first stage of making leather.**

*(Images: Credit Amanda Michel)*

Continues as:

## “Overview” Part 2

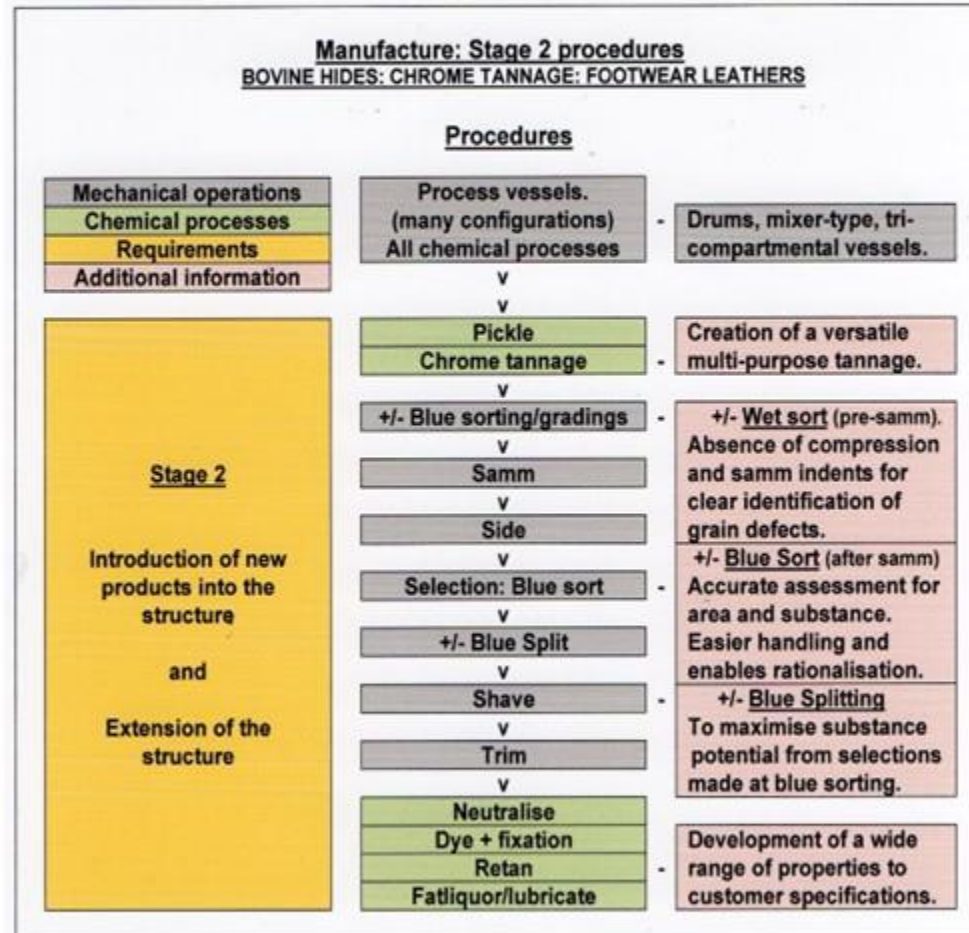

- Within Stage 2 procedures, new materials are introduced into the collagen structure.
- Controlled additions of chemicals are made to stabilise the structure (*tanning*) and to produce leather.
- The leather properties are then amended by further chemical offers in retanning, dyeing and fatliquoring processes, to meet customer specifications.
- Extension of the hides and skins from a natural rounded structure to a flattened form continues throughout all mechanical operations.